

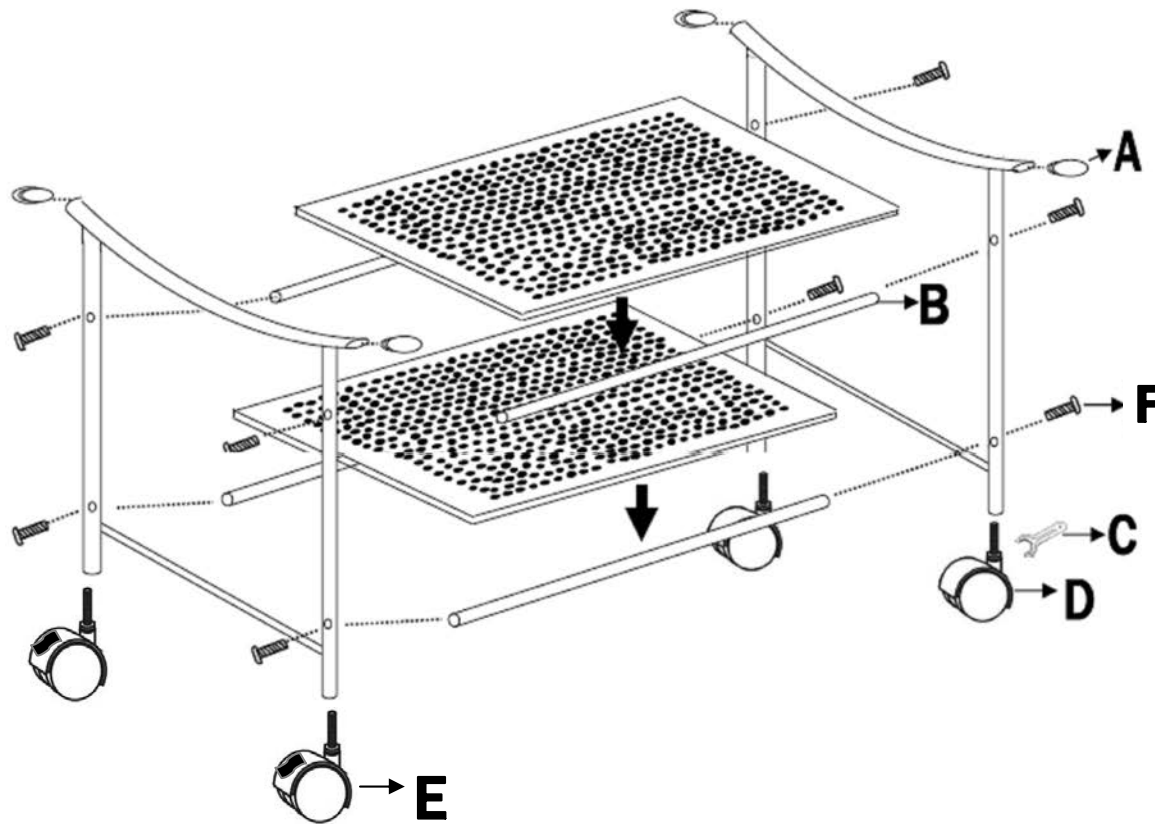





83481-09 ACHERON 1



 D x 2	 A x 4
 E x 2	 B x 4
 F x 8	 C x 1

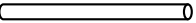